

Surge Protection



Powering Business Worldwide

SG05013



Poles	Max. Continuous Operating Voltage U_c	Type Designation	Article No.	Units per package
-------	--	---------------------	-------------	----------------------

Combined Surge Protective Device SPRT12-350

- incl. FM contact (change-over contact)
- for TN-C

sg04518_r



3pole	350 VAC	SPRT12-350/3-AX	195235	1
-------	---------	-----------------	--------	---

- incl. FM contact (change-over contact)
- for TN-S/TT

sg04418_r



3pole+NPE	350 VAC	SPRT12-350/3+NPE-AX	195236	1
-----------	---------	---------------------	--------	---

Range of protection	Max. Continuous Operating Voltage U_c	Type Designation	Article No.	Units per package
---------------------	--	---------------------	-------------	----------------------

Insert for SPRT12-350

sg04318_r



L-N / L-PEN	350 VAC	SPRT12-350	195237	1
N-PE	350 VAC	SPRT12-350/NPE	195238	1

Description Surge Protective Class T1/T2

- Ready-to-connect Combined Surge Protection Device Type 1/2 on the basis of spark gaps
- Consisting of the base unit and plug-type modules

Technical Data

	SPRT12-350/3-AX	SPRT12-350/3+NPE-AX
General data		
Standards/regulations	IEC 61643-11, EN 61643-11	IEC 61643-11, EN 61643-11
IEC test classification	T1 / T2	T1 / T2
EN type	T1 / T2	T1 / T2
Number of ports	One	One
SPD design	Voltage-switching type	Voltage-switching type
Mode of protection	L-PEN	L-N, L-PE, N-PE
Mounting type	DIN rail 35 mm	DIN rail 35 mm
Surge protection fault message	Optical, remote indicator contact	Optical, remote indicator contact
Color	Light grey RAL 7035	Light grey RAL 7035
Insulating material	PBT-FR	PBT-FR
Housing material	PBT-FR	PBT-FR
Air clearances and creepage distances (according to EN 60664-1 and EN 61643-11)		
Degree of pollution	2	2
Overvoltage category	III	III
Material group	I	I
CTI value of material	≥ 600	≥ 600
U _{max}	< 2 kV	< 2 kV
Flammability rating according to UL 94	V-0	V-0
Degree of protection	IP20 (only when all terminal points are used)	IP20 (only when all terminal points are used)
Shock (operation)	30 g (Half-sine / 11 ms / 3x ±X, ±Y, ±Z)	30 g (Half-sine / 11 ms / 3x ±X, ±Y, ±Z)
Vibration (operation)	5 g (5 - 500 Hz/2.5 h/X, Y, Z)	5 g (5 - 500 Hz/2.5 h/X, Y, Z)
Ambient temperature (operation)	-40 °C ... 80 °C	-40 °C ... 80 °C
Ambient temperature (storage/transport)	-40 °C ... 80 °C	-40 °C ... 80 °C
Permissible humidity (operation)	5 % ... 95 %	5 % ... 95 %
Altitude	≤ 2000 m (amsl (above mean sea level))	≤ 2000 m (amsl (above mean sea level))
Width	106.8 mm	142.4 mm
Height	97 mm	95 mm
Depth	71.2 mm (incl. DIN rail 7.5 mm)	71.2 mm (incl. DIN rail 7.5 mm)
Horizontal pitch	6 Module units	8 Module units
Electrical data		
Nominal voltage	U _N 240/415 V AC (TN-C)	240/415 V AC (TN-S) 240/415 V AC (TT)
Nominal frequency	f _N 50 Hz (60 Hz)	50 Hz (60 Hz)
Maximum continuous operating voltage	U _C 350 V AC	350 V AC
Reference test voltage	U _{REF} 264 V AC	264 V AC
Rated load current	I _L 125 A (< 55 °C)	125 A (< 55 °C)
Nominal discharge current (8/20) μs	I _n	
(L-PEN)	25 kA	-
(L-N)	-	25 kA
(L-PE)	-	25 kA
(N-PE)	-	100 kA
Maximum discharge current (8/20) μs	I _{max}	
(L-PEN)	50 kA	-
(L-N)	-	50 kA
(L-PE)	-	50 kA
Impulse discharge current (10/350) μs		
Peak value	I _{imp} 25 kA (L-PEN)	25 kA (L-N)
Charge	12.5 As (L-PEN)	12.5 As (L-N)
Specific energy	160 kJ/Ω (L-PEN)	160 kJ/Ω (L-N)
Impulse discharge current (10/350) μs (L-PE)		
Peak value	I _{imp} -	25 kA
Charge	-	12.5 As
Specific energy	-	160 kJ/Ω

		SPRT12-350/3-AX	SPRT12-350/3+NPE-AX
Impulse discharge current (10/350) μ s (N-PE)			
Peak value	I_{imp}	-	100 kA
Charge		-	50 As
Specific energy		-	2500 kJ/ Ω
Total discharge current (10/350) μ s	I_{total}	75 kA	100 kA
Follow current interrupt rating	I_{fi}		
(L-PEN)		50 kA	-
(L-N)		-	50 kA
(N-PE)		-	100 A
Short-circuit current rating	I_{SCCR}	50 kA	50 kA
Voltage protection level	U_p		
(L-PEN)		≤ 1.5 kV	-
(L-N)		-	≤ 1.5 kV
(L-PE)		-	≤ 2.5 kV
(N-PE)		-	≤ 1.5 kV
Residual voltage	U_{res}		
(L-PEN)		≤ 1.5 kV (at I_n)	-
(L-N)		-	≤ 1.5 kV (at I_n)
(L-PE)		-	≤ 2.5 kV (at I_n)
(N-PE)		-	≤ 1.5 kV (at I_n)
Front of wave sparkover voltage at 6 kV (1.2/50) μ s			
(L-PEN)		≤ 1.5 kV	-
(L-N)		-	≤ 1.5 kV
(L-PE)		-	≤ 2.5 kV
(N-PE)		-	≤ 1.5 kV
TOV behavior at U_T			
(L-PEN)		415 V AC (5 s / withstand mode)	-
		457 V AC (120 min / withstand mode)	-
(L-N)		-	415 V AC (5 s / withstand mode)
			457 V AC (120 min / withstand mode)
(N-PE)		-	1200 V AC (200 ms / withstand mode)
Response time	t_A	≤ 100 ns	≤ 100 ns
Current tripping factor	k	1.6	1.6
Max. backup fuse with branch wiring		315 A (gG)	315 A (gG)
Max. backup fuse with V-type through wiring (at 35 mm ²)		125 A (gG)	125 A (gG)
Additional technical data			
Follow current interrupt rating	I_{fi}	100 kA (264 V AC)	100 kA (264 V AC) (L-N)
Short-circuit current rating	I_{SCCR}	100 kA (264 V AC)	100 kA (264 V AC)
Remote signaling			
Connection name		Remote fault indicator contact	Remote fault indicator contact
Switching function		PDT contact	PDT contact
Connection method		Plug-in/screw connection via COMBICON	Plug-in/screw connection via COMBICON
Operating voltage		12 V AC ... 250 V AC 125 V DC (200 mA DC)	12 V AC ... 250 V AC 125 V DC (200 mA DC)
Operating current		10 mA AC ... 1 A AC 1 A DC (30 V DC)	10 mA AC ... 1 A AC 1 A DC (30 V DC)
Screw thread		M2	M2
Conductor cross section			
flexible		0.14 mm ² ... 1.5 mm ²	0.14 mm ² ... 1.5 mm ²
solid		0.14 mm ² ... 1.5 mm ²	0.14 mm ² ... 1.5 mm ²
AWG		28 ... 16	28 ... 16
Stripping length		7 mm	7 mm
Tightening torque		0.25 Nm	0.25 Nm
Connection data			
Connection method		Screw terminal blocks	Screw terminal blocks
Screw thread		M5	M5
Connection technology		Biconnect terminal block	Biconnect terminal block
Conductor cross section			
flexible, solid		2.5 mm ² ... 35 mm ²	2.5 mm ² ... 35 mm ²
AWG		13 ... 2	13 ... 2
Stripping length		18 mm	18 mm
Connection method		Fork-type cable lug	Fork-type cable lug
Diameter		5 mm	5 mm
Conductor cross section flexible		1.5 mm ² ... 16 mm ²	1.5 mm ² ... 16 mm ²
Tightening torque		4.5 Nm	4.5 Nm

Circuit diagrams

SPRT12-350/3-AX

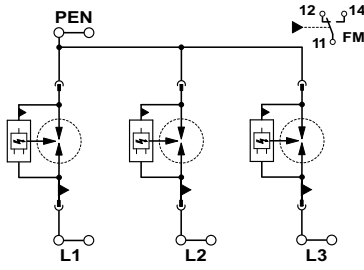

SPRT12-350/3+NPE-AX

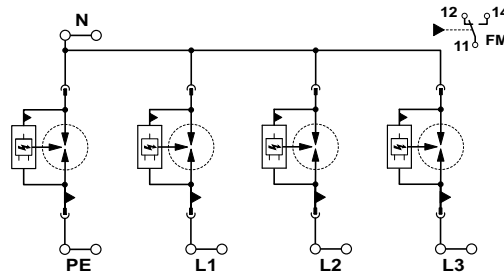

SPRT12-350, SPRT12-350/NPE

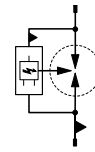

Dimensions (mm)

SPRT12-350/3-AX

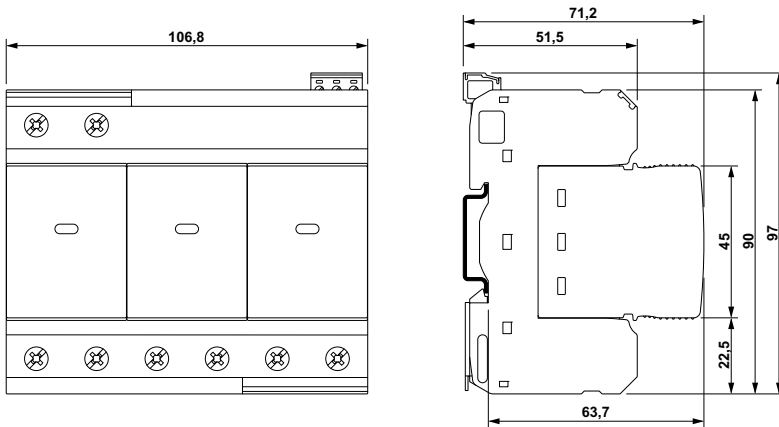

SPRT12-350/3+NPE-AX

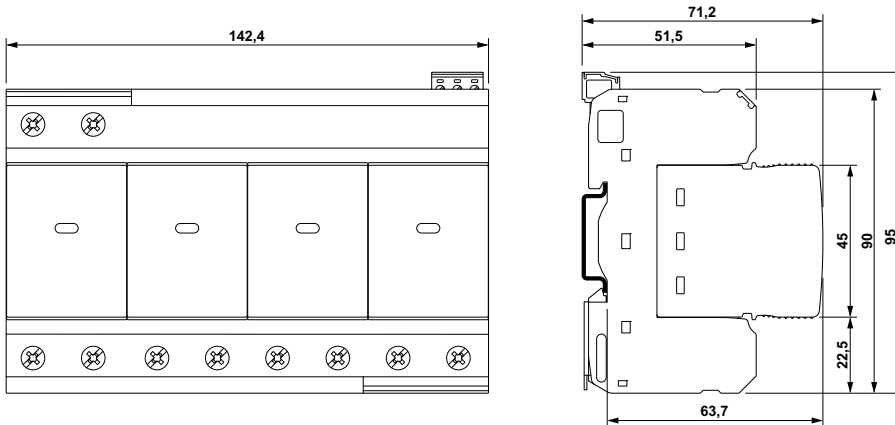

SPRT12-350, SPRT12-350/NPE

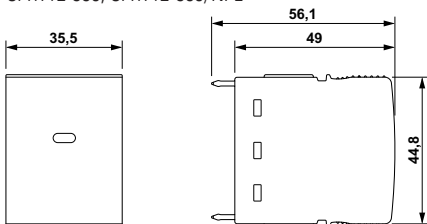

1.6

Surge Protection

xPole

Surge Protective Class T1/T2 for busbar mounting (40 mm), SPST12(H)-255

Poles	Max. Continuous Operating Voltage U_c	Type Designation	Article No.	Units per package
-------	--	---------------------	-------------	----------------------

Combined Surge Protective Device SPST12(H)-255

• for TT /TN-C-S

sg06418_r



3pole+NPE	255 VAC	SPST12-255/3+NPE	195603	1
		SPST12H-255/3+NPE	195605	1

• for TN-C

sg06318_r



3pole	255 VAC	SPST12-255/3	195602	1
		SPST12H-255/3	195604	1

Description Surge Protective Class T1/T2 for busbar mounting (40 mm), SPST12(H)-255

- Ready-to-connect Combined Surge Protection Device Type 1/2 on the basis of spark gaps
- For mounting on 40 mm busbars
- Scope of application:
To protect consumer systems against transient overvoltages caused by direct and indirect lightning strikes, as well as switching operations
- Lightning protection class III and IV according to IEC 62305
- Meets all requirements for the installation of surge protection according to DIN VDE 0100-534
- For electrical system TN-C

Technical Data

	SPST12-255/3	SPST12H-255/3
General data		
Standards/regulations	IEC 61643-11 2011, EN 61643-11 2012	IEC 61643-11 2011, EN 61643-11 2012
IEC test classification	T1 / T2	T1 / T2
EN type	T1 / T2	T1 / T2
Number of ports	One	One
SPD design	Voltage-switching type	Voltage-switching type
Mode of protection	L-PEN	L-PEN
Mounting type	Busbar 40 mm	Busbar 40 mm
Surge protection fault message	Optical	Optical
Color	Light grey RAL 7035	Light grey RAL 7035
Insulating material	PC	PC
Housing material	PA 6.6-FR, PC	PA 6.6-FR, PC
Air clearances and creepage distances (according to EN 60664-1 and EN 61643-11)		
Degree of pollution	2	2
Overvoltage category	IV	IV
Material group	IIIa	IIIa
CTI value of material	≥ 175	≥ 175
U _{max}	1.5 kV	1.5 kV
Flammability rating according to UL 94	V-0	V-0
Degree of protection	IP30 (installed)	IP30 (installed)
Ambient temperature (operation)	-40 °C ... 80 °C	-40 °C ... 80 °C
Ambient temperature (storage/transport)	-40 °C ... 80 °C	-40 °C ... 80 °C
Permissible humidity (operation)	5 % ... 95 %	5 % ... 95 %
Altitude	≤ 6000 m (amsl (above mean sea level))	≤ 6000 m (amsl (above mean sea level))
Width	47 mm	47 mm
Height	223.2 mm	223.2 mm
Depth	110.7 mm	110.7 mm
Horizontal pitch	2.6 Module units	2.6 Module units
Electrical data		
Nominal voltage	U _N 230/400 V AC (TN-C)	230/400 V AC (TN-C)
Nominal frequency	f _N 50 Hz (60 Hz)	50 Hz (60 Hz)
Maximum continuous operating voltage	U _C 255 V AC	255 V AC
Reference test voltage	U _{REF} 255 V AC	255 V AC
Nominal discharge current (8/20) μs	I _n 20 kA	20 kA
Impulse discharge current (10/350) μs		
Peak value	I _{imp} 7.5 kA	12.5 kA
Charge	3.75 As	6.25 As
Specific energy	15 kJ/Ω	39 kJ/Ω
Follow current interrupt rating	I _{fi} 25 kA	25 kA
Short-circuit current rating	I _{SCCR} 25 kA	25 kA
Voltage protection level	U _p ≤ 1.5 kV	≤ 1.5 kV
Front of wave sparkover voltage at 6 kV (1.2/50) μs	-	≤ 1.5 kV
TOV behavior at U _T	337 V AC (5 s / withstand mode) 442 V AC (120 min / safe failure mode)	337 V AC (5 s / withstand mode) 442 V AC (120 min / safe failure mode)
Response time	t _A ≤ 100 ns	≤ 100 ns
Insulation resistance	R _{ISO} > 5 MΩ (500 V DC)	> 5 MΩ (500 V DC)
Current tripping factor	k 1.6	1.6
Max. backup fuse with branch wiring	250 A (gG)	250 A (gG)

1.8

Surge Protection

xPole

Surge Protective Class T1/T2 for busbar mounting (40 mm), SPST12(H)-255

	SPST12-255/3	SPST12H-255/3
Connection data		
Connection method	Screw terminal blocks	Screw terminal blocks
Screw thread	M5	M5
Conductor cross section		
flexible, solid	2.5 mm ² ... 35 mm ²	2.5 mm ² ... 35 mm ²
Stripping length	18 mm	18 mm
Tightening torque	4.5 Nm	4.5 Nm

Circuit diagram

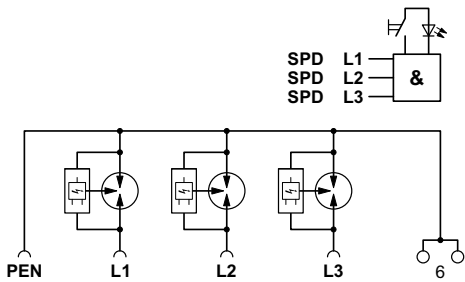

Dimensions (mm)

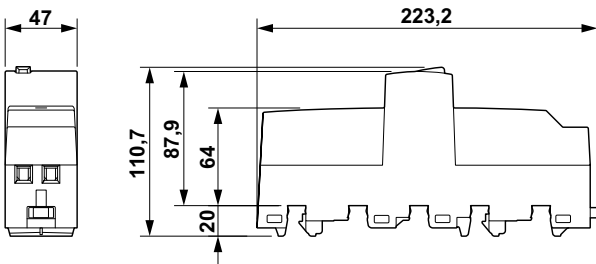

Description Surge Protective Class T1/T2 for busbar mounting (40 mm), SPST12(H)-255/3+NPE

- Ready-to-connect Combined Surge Protection Device Type 1/2 on the basis of spark gaps
- For mounting on 40 mm busbars
- Scope of application:
To protect consumer systems against transient overvoltages caused by direct and indirect lightning strikes, as well as switching operations
- Lightning protection class III and IV according to IEC 62305
- Meets all requirements for the installation of surge protection according to DIN VDE 0100-534
- For electrical system TT / TN-C-S

Technical Data

		SPST12-255/3+NPE	SPST12H-255/3+NPE
General data			
Standards/regulations		IEC 61643-11 2011, EN 61643-11 2012	IEC 61643-11 2011, EN 61643-11 2012
IEC test classification		T1 / T2	T1 / T2
EN type		T1 / T2	T1 / T2
Number of ports		One	One
SPD design		Voltage-switching type	Voltage-switching type
Mode of protection		L-N, L-PE, N-PE	L-N, L-PE, N-PE
Mounting type		Busbar 40 mm	Busbar 40 mm
Surge protection fault message		Optical	Optical
Color		Light grey RAL 7035	Light grey RAL 7035
Insulating material		PC	PC
Housing material		PA 6.6-FR, PC	PA 6.6-FR, PC
Air clearances and creepage distances (according to EN 60664-1 and EN 61643-11)			
Degree of pollution		2	2
Overvoltage category		IV	IV
Material group		IIIa	IIIa
CTI value of material		≥ 175	≥ 175
U _{max}		1.5 kV (L-N), 2 kV (L-PE), 1.5 kV (N-PE)	1.5 kV (L-N), 2 kV (L-PE), 1.5 kV (N-PE)
Flammability rating according to UL 94		V-0	V-0
Degree of protection		IP30 (installed)	IP30 (installed)
Ambient temperature (operation)		-40 °C ... 80 °C	-40 °C ... 80 °C
Ambient temperature (storage/transport)		-40 °C ... 80 °C	-40 °C ... 80 °C
Permissible humidity (operation)		5 % ... 95 %	5 % ... 95 %
Altitude		≤ 6000 m (amsl (above mean sea level))	≤ 6000 m (amsl (above mean sea level))
Width		47 mm	47 mm
Height		223.2 mm	223.2 mm
Depth		110.7 mm	110.7 mm
Horizontal pitch		2.6 Module units	2.6 Module units
Electrical data			
Nominal voltage	U _N	230/400 V AC (TN-S) 230/400 V AC (TT)	230/400 V AC (TN-S) 230/400 V AC (TT)
Nominal frequency	f _N	50 Hz (60 Hz)	50 Hz (60 Hz)
Maximum continuous operating voltage	U _C	255 V AC	255 V AC
Reference test voltage	U _{REF}	255 V AC	255 V AC
Residual current	I _{PE}	≤ 5 μA	≤ 5 μA
Nominal discharge current (8/20) μs	I _n		
(L-N)		20 kA	20 kA
(L-PE)		20 kA	20 kA
(N-PE)		80 kA	80 kA
Impulse discharge current (10/350) μs (L-N)			
Peak value	I _{imp}	7.5 kA	12.5 kA
Charge		3.75 As	6.25 As
Specific energy		15 kJ/Ω	39 kJ/Ω
Impulse discharge current (10/350) μs (L-PE)			
Peak value	I _{imp}	7.5 kA	12.5 kA
Charge		3.75 As	6.25 As
Specific energy		15 kJ/Ω	39 kJ/Ω
Impulse discharge current (10/350) μs (N-PE)			
Peak value	I _{imp}	30 kA	50 kA
Charge		15 As	25 As
Specific energy		225 kJ/Ω	625 kJ/Ω

1.10

Surge Protection

xPole

Surge Protective Class T1/T2 for busbar mounting (40 mm), SPST12(H)-255

		SPST12-255/3+NPE	SPST12H-255/3+NPE
Follow current interrupt rating	I_{fi}		
	(L-N)	25 kA	25 kA
	(L-PE)	25 kA	25 kA
	(N-PE)	100 A	100 A
Short-circuit current rating	I_{SCCR}	25 kA	25 kA
Voltage protection level	U_p		
	(L-N)	≤ 1.5 kV	≤ 1.5 kV
	(L-PE)	≤ 2 kV	≤ 2 kV
	(N-PE)	≤ 1.5 kV	≤ 1.5 kV
Front of wave sparkover voltage at 6 kV (1.2/50) μ s			
	(L-N)	≤ 1.5 kV	≤ 1.5 kV
	(L-PE)	≤ 2 kV	≤ 2 kV
	(N-PE)	≤ 1.5 kV	≤ 1.5 kV
TOV behavior at U_T			
	(L-N)	337 V AC (5 s / withstand mode) 442 V AC (120 min / safe failure mode)	337 V AC (5 s / withstand mode) 442 V AC (120 min / safe failure mode)
	(L-PE)	442 V AC (120 min / withstand mode) 1455 V AC (200 ms / withstand mode)	442 V AC (120 min / withstand mode) 1455 V AC (200 ms / withstand mode)
	(N-PE)	1200 V AC (200 ms / withstand mode)	1200 V AC (200 ms / withstand mode)
Response time	t_A	≤ 100 ns	≤ 100 ns
Insulation resistance	R_{iso}	> 5 M Ω (500 V DC)	> 5 M Ω (500 V DC)
Current tripping factor	k	1.6	1.6
Max. backup fuse with branch wiring		250 A (gG)	250 A (gG)
Connection data			
Connection method		Screw terminal blocks	Screw terminal blocks
Screw thread		M5	M5
Conductor cross section			
	flexible, solid	2.5 mm ² ... 35 mm ²	2.5 mm ² ... 35 mm ²
Stripping length		18 mm	18 mm
Tightening torque		4.5 Nm	4.5 Nm

Circuit diagram

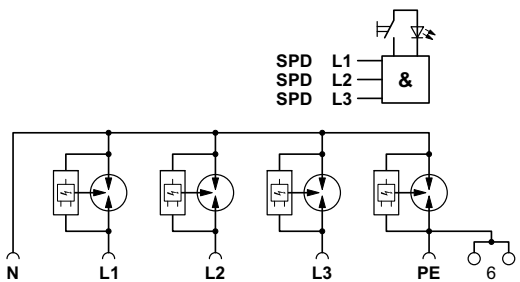

Dimensions (mm)

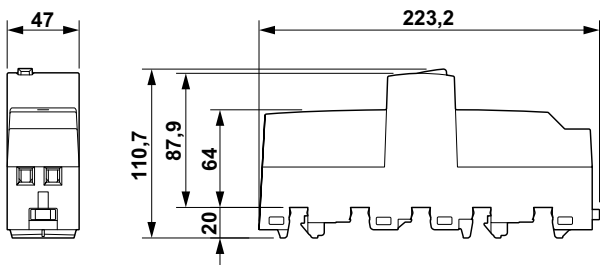

Description	Type Designation	Article No.	Units per package
-------------	------------------	-------------	-------------------

Lightning current arrester - surge arrester sets, Lightning protection classes III, IV

Without remote indication

TN-S/TT Set 1+N Set	SPBT12-280-1+NPE50	184752	1 / 30
TN-S-Set 2pole	SPBT12-280/2	158309	1 / 60
TN-C-Set 3pole	SPBT12-280/3	158330	1 / 40
TN-S-Set 4pole	SPBT12-280/4	158331	1 / 30
TN-S/TT Set 3+N Set	SPBT12-280-3+NPE50	184750	1 / 60
TN-S/TT Set 3+N Set with busbar	SPBT12-280-3+NPE50/BB	184751	1
TN-S/TT-Set 1+1pole	SPBT12-280-1+NPE	158308	1 / 40
TN-S/TT-Set 3+1pole	SPBT12-280-3+NPE	158332	1 / 20
TN-S/TT-Set 3+1pole	SPBT12-280-3+NPE/BB	158333	1

Accessories

Auxiliary switch for SPBT12-280	ASAUWSC-SPM	131785	4 / 120
Busbar	ZV-KSBI...		

SG29612



SPBT12-280/3

Impulse current I_{imp} (10/350) μ s	Type Designation	Article No.	Units per package
---	------------------	-------------	-------------------

Lightning current arrester - surge arrester SPBT12

Complete

12.5 kA L - (PE) N	SPBT12-280/1	158306	12 / 120
50 kA N-PE	SPBT12-NPE50	184749	1 / 60
100 kA N-PE	SPBT12-NPE100	158307	1 / 60

SG27112



SPBT12-280/1

Insert

12.5 kA Insert	SPBT12-280	167341	4 / 120
----------------	------------	--------	---------



sg63312



Description Surge Protective Class T1&T2

- Field of application:
For the protection of low voltage distribution systems against transient overvoltage caused by direct and indirect lightning stroke and switching operations
- Application according to IEC 60364-5-53 Clause 534
- Test class **I**, **II** according to IEC 61643-1
- SPD-type **T1**, **T2** according to EN 61643-11
- Lightning protection classes III and IV according to IEC 62305
- Busbars ZV-KSBI are available for all customary applications

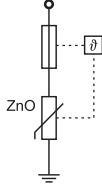
Technical Data

		SPBT12-280...	SPBT12-NPE50	SPBT12-NPE100
Electrical	per pole			
Responding time (rate of voltage rise 5 kV/μs)		< 25 ns	< 100 ns	< 100 ns
Voltage protection level	U_p	< 1.5 kV	< 1.4 kV	< 1.5 kV
Voltage protection level at 5 kA (8/20) μs	U_p	950 V	—	—
Max. continuous operating voltage	U_c	280 VAC	260 VAC	255 VAC
TOV test value	U_T	370 VAC (5 s)	1200 VAC (200 ms)	1200 VAC (200 ms)
Rated frequency		50/60 Hz	50/60 Hz	50/60 Hz
Open circuit voltage	U_{oc}	10 kV	—	20 kV
Nominal discharge current (8/20) μs	I_n	25 kA	50 kA	100 kA
Max. discharge current	I_{max}	50 kA	100 kA	100 kA
Impulse current (10/350) μs	I_{imp}			
Peak current		12.5 kA	50 kA	100 kA
Charge Q		6.25 As	25 As	50 As
Specific energy		39,1 kJ/Ω	625 kJ/Ω	2500 kJ/Ω
Follow current interrupt rating	I_{fi}	—	100 A _{r.m.s.}	100 A _{r.m.s.}
Maximum back-up fuse		160 AgL/gG	—	—
Maximum short-circuit current		50 A _{r.m.s.}	—	—
Connection diagram				

Mechanical

Frame size	45 mm	45 mm	45 mm
Device height	80 mm	80 mm	80 mm
Device width	17.5 mm	17.5 mm	35 mm
Weight	121 g	93 g	250 g
Permitted ambient temperature	-40°C to +70°C	-40°C to +70°C	-40°C to +70°C
Degree of protection (built-in)	IP40	IP40	IP40
Upper and lower lift terminal capacity	4 - 25 mm ²	top 4 - 50 mm ² ; bottom 4 - 35 mm ²	4 - 35 mm ²
Upper and lower open mouthed terminals for busbar thickness up to	1.5 mm	top - / bottom 1.5 mm	1.5 mm
Tightening torque of terminal screws	2.4 - 3 Nm	2.4 - 3 Nm	2.4 - 3 Nm
Quick fastening on DIN rail according to	IEC/EN 60715	IEC/EN 60715	IEC/EN 60715
Accessories: busbars 16 mm ²	Type ZV-KSBI ...	Type ZV-KSBI ...	Type ZV-KSBI ...

Dimensions (mm)

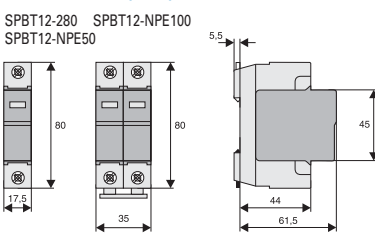

Lightning current arrester - surge arrester sets, Lightning protection classes III, IV

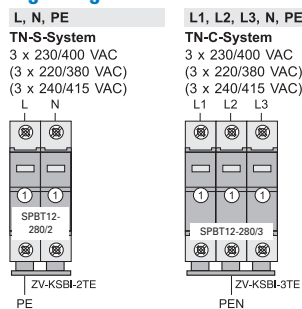

① ... SPBT12-280

Technical Data

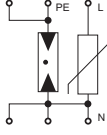
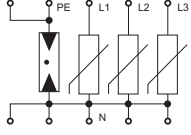
		SPBT12-280-1+NPE50	SPBT12-280-3+NPE50
Electrical			
		per pole	
Responding time (rate of voltage rise 5 kV/μs)	L-N / N-PE	< 25 ns / < 100 ns	< 25 ns / < 100 ns
Voltage protection level	L-N / L-PE / N-PE	U_p < 1.5 kV	< 1.5 kV
Max. continuous operating voltage	L-N / N-PE	U_c 280 VAC / 260 VAC	280 VAC / 260 VAC
TOV test value		U_T	
5 s	L-N / L-PE	348 VAC / 370 VAC	348 VAC / 370 VAC
200 ms	N-PE	1200 VAC	1200 VAC
Rated frequency		50/60 Hz	50/60 Hz
Open circuit voltage		U_{oc} 10 kV	20 kV
Nominal discharge current (8/20) μs	L-N / N-PE	I_n 25 kA / 50 kA	3x25 kA / 50 kA
Max. discharge current	L-N / N-PE	I_{max} 50 kA / 100 kA	3x50 kA / 100 kA
Impulse current (10/350) μs		I_{imp}	
Peak current	L-N / N-PE	12.5 kA / 50 kA	3x12.5 kA / 50 kA
Charge Q		25 As	25 As
Specific energy		625 kJ/Ω	625 kJ/Ω
Follow current interrupt rating	N-PE	I_{fi} 100 A _{r.m.s.}	100 A _{r.m.s.}
Maximum back-up fuse		—	—
Maximum short-circuit current		—	—
Connection diagram			
Mechanical			
Frame size		45 mm	45 mm
Device height		80 mm	80 mm
Device width		35 mm	70 mm
Weight		218 g	470 g
Permitted ambient temperature		-40°C to +70°C	-40°C to +70°C
Degree of protection (built-in)		IP40	IP40
Upper and lower lift terminal capacity			
L, N		4 - 25 mm ²	4 - 25 mm ²
N, PE		4 - 50 mm ²	4 - 50 mm ²
Upper and lower open mouthed terminals for busbar thickness up to		1.5 mm	1.5 mm
Tightening torque of terminal screws		2.4 - 3 Nm	2.4 - 3 Nm
Quick fastening on DIN rail according to		IEC/EN 60715	IEC/EN 60715
Accessories: busbars 16 mm ²		Type ZV-KSBI ...	Type ZV-KSBI ...

Lightning current arrester - surge arrester sets, Lightning protection classes III, IV

L, N, PE

TN-S-System
 3 x 230/400 VAC
 (3 x 220/380 VAC)
 (3 x 240/415 VAC)

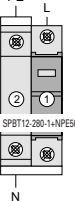

SPBT12-280-1+NPE50

L1, L2, L3, N, PE

TN-S/TT-System
 3 x 230/400 VAC
 (3 x 220/380 VAC)
 (3 x 240/415 VAC)

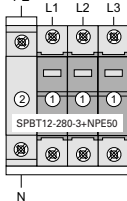

SPBT12-280-3+NPE50

TN-S/TT-System
 3 x 230/400 VAC
 (3 x 220/380 VAC)
 (3 x 240/415 VAC)

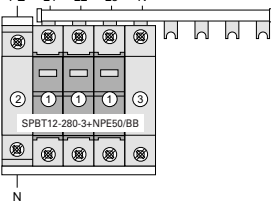

SPBT12-280-3+NPE50/BB

① ... SPBT12-280

② ... SPBT12-NPE50

③ ... ASLTT-63

Technical Data

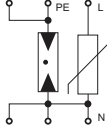
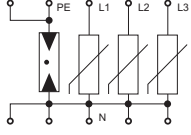
		SPBT12-280-1+NPE	SPBT12-280-3+NPE
Electrical		per pole	
Responding time (rate of voltage rise 5 kV/ μ s)	L-N / N-PE	< 25 ns / < 100 ns	< 25 ns / < 100 ns
Voltage protection level	L-N / L-PE / N-PE	U_d < 1.5 kV	< 1.5 kV
Max. continuous operating voltage	L-N / N-PE	U_C 280 VAC / 255 VAC	280 VAC / 255 VAC
TOV test value		U_T	
5 s	L-N / L-PE	348 VAC / 370 VAC	348 VAC / 370 VAC
200 ms	N-PE	1200 VAC	1200 VAC
Rated frequency		50/60 Hz	50/60 Hz
Open circuit voltage		U_{oc} 10 kV	20 kV
Nominal discharge current (8/20) μ s	L-N / N-PE	I_n 25 kA / 100 kA	3x25 kA / 100 kA
Max. discharge current	L-N / N-PE	I_{max} 50 kA / 100 kA	3x50 kA / 100 kA
Impulse current (10/350) μ s		I_{imp}	
Peak current	L-N / N-PE	12.5 kA / 100 kA	3x12.5 kA / 100 kA
Charge Q		50 As	50 As
Specific energy		2500 kJ/ Ω	2500 kJ/ Ω
Follow current interrupt rating	N-PE	I_{fi} 100 A _{r.m.s.}	100 A _{r.m.s.}
Maximum back-up fuse		160 AgL/gG	160 AgL/gG
Maximum short-circuit current		50 kA _{r.m.s.}	50 kA _{r.m.s.}
Connection diagram			
Mechanical			
Frame size		45 mm	45 mm
Device height		80 mm	80 mm
Device width		52.5 mm	87.5 mm
Weight		375 g	626 g
Permitted ambient temperature		-40°C to +70°C	-40°C to +70°C
Degree of protection (built-in)		IP40	IP40
Upper and lower lift terminal capacity			
L, N		4 - 25 mm ²	4 - 25 mm ²
N, PE		4 - 35 mm ²	4 - 35 mm ²
Upper and lower open mouthed terminals for busbar thickness up to		1.5 mm	1.5 mm
Tightening torque of terminal screws		2.4 - 3 Nm	2.4 - 3 Nm
Quick fastening on DIN rail according to		IEC/EN 60715	IEC/EN 60715
Accessories: busbars 16 mm ²		Type ZV-KSBI ...	Type ZV-KSBI ...

Lightning current arrester - surge arrester sets, Lightning protection classes III, IV

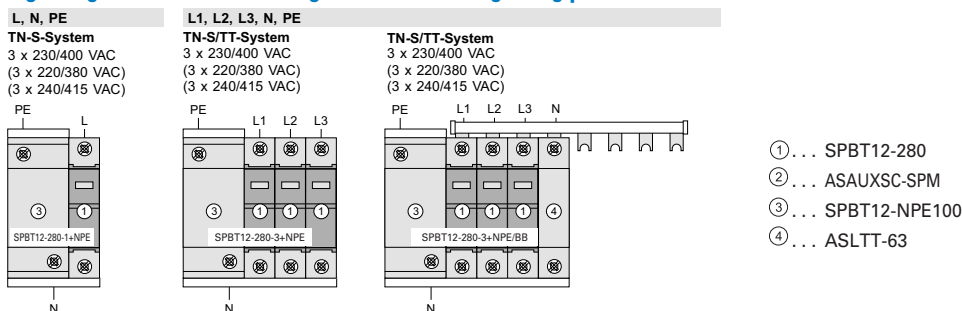

Poles	Max. Continuous Operating Voltage U_c	I_n (8/20) μ s	Type Designation	Article No.	Units per package
-------	---	----------------------	------------------	-------------	-------------------

Plug-in surge arrester SPCT2. 1- to 4pole

Complete (2- and multi-pole surge arresters are supplied with busbar)

1pole	75 VAC	20 kA	SPCT2-075/1	167578	12/120
1pole	135 VAC	20 kA	SPCT2-135/1	167583	12/120
1pole	175 VAC	20 kA	SPCT2-175/1	167588	12/120
1pole	280 VAC	20 kA	SPCT2-280/1	167593	12/120
1pole	335 VAC	20 kA	SPCT2-335/1	167598	12/120
1pole	385 VAC	20 kA	SPCT2-385/1	167603	12/120
1pole	460 VAC	20 kA	SPCT2-460/1	167608	12/120
1pole	580 VAC	20 kA	SPCT2-580/1	167613	12/120
1pole	260 VAC	30 kA	SPCT2-NPE60/1	167618	12/120
2pole	75 VAC	2x20 kA	SPCT2-075/2	167579	1/60
2pole	135 VAC	2x20 kA	SPCT2-135/2	167584	1/60
2pole	175 VAC	2x20 kA	SPCT2-175/2	167589	1/60
2pole	280 VAC	2x20 kA	SPCT2-280/2	167594	1/60
2pole	335 VAC	2x20 kA	SPCT2-335/2	167599	1/60
2pole	385 VAC	2x20 kA	SPCT2-385/2	167604	1/60
2pole	460 VAC	2x20 kA	SPCT2-460/2	167609	1/60
2pole	580 VAC	2x20 kA	SPCT2-580/2	167614	1/60
3pole	75 VAC	3x20 kA	SPCT2-075/3	167580	1/40
3pole	135 VAC	3x20 kA	SPCT2-135/3	167585	1/40
3pole	175 VAC	3x20 kA	SPCT2-175/3	167590	1/40
3pole	280 VAC	3x20 kA	SPCT2-280/3	167595	1/40
3pole	335 VAC	3x20 kA	SPCT2-335/3	167600	1/40
3pole	385 VAC	3x20 kA	SPCT2-385/3	167605	1/40
3pole	460 VAC	3x20 kA	SPCT2-460/3	167610	1/40
3pole	580 VAC	3x20 kA	SPCT2-580/3	167615	1/40
4pole	75 VAC	4x20 kA	SPCT2-075/4	167581	1/30
4pole	135 VAC	4x20 kA	SPCT2-135/4	167586	1/30
4pole	175 VAC	4x20 kA	SPCT2-175/4	167591	1/30
4pole	280 VAC	4x20 kA	SPCT2-280/4	167596	1/30
4pole	335 VAC	4x20 kA	SPCT2-335/4	167601	1/30
4pole	385 VAC	4x20 kA	SPCT2-385/4	167606	1/30
4pole	460 VAC	4x20 kA	SPCT2-460/4	167611	1/30
4pole	580 VAC	4x20 kA	SPCT2-580/4	167616	1/30
1+N	280 VAC	20 kA	SPCT2-280-1+NPE	167619	1/60
1+N	335 VAC	20 kA	SPCT2-335-1+NPE	167621	1/60
1+N	385 VAC	20 kA	SPCT2-385-1+NPE	167623	1/60
1+N	460 VAC	20 kA	SPCT2-460-1+NPE	167625	1/60
1+N	580 VAC	20 kA	SPCT2-580-1+NPE	167627	1/60
3+N	280 VAC	20 kA	SPCT2-280-3+NPE	167620	1/30
3+N	335 VAC	20 kA	SPCT2-335-3+NPE	167622	1/30
3+N	385 VAC	20 kA	SPCT2-385-3+NPE	167624	1/30
3+N	460 VAC	20 kA	SPCT2-460-3+NPE	167626	1/30
3+N	580 VAC	20 kA	SPCT2-580-3+NPE	167628	1/30
3+N/BB	280 VAC	3x20 kA	SPCT2-280-3+NPE/BB	167629	1
3+N/BB	335 VAC	3x20 kA	SPCT2-335-3+NPE/BB	167630	1
3+N/BB	385 VAC	3x20 kA	SPCT2-385-3+NPE/BB	167631	1
3+N/BB	460 VAC	3x20 kA	SPCT2-460-3+NPE/BB	167632	1

Plug-in surge arrester SPCT2. Insert

Insert 1pole

Insert	75 VAC	20 kA	SPCT2-075	167577	4/120
Insert	135 VAC	20 kA	SPCT2-135	167582	4/120
Insert	175 VAC	20 kA	SPCT2-175	167587	4/120
Insert	280 VAC	20 kA	SPCT2-280	167592	4/120
Insert	335 VAC	20 kA	SPCT2-335	167597	4/120
Insert	385 VAC	20 kA	SPCT2-385	167602	4/120
Insert	460 VAC	20 kA	SPCT2-460	167607	4/120
Insert	580 VAC	20 kA	SPCT2-580	167612	4/120
Insert	260 VAC	30 kA	SPCT2-NPE60	167617	4/120

SG04713



SPCT2-280/3

sg08213



Description Surge Protective Class T2

- Field of application:
For the protection of low voltage distribution systems against transient overvoltage caused by direct and indirect lightning stroke and switching operations
- Test class **[II]** according to IEC 61643-1+A1
- SPD-type **[T2]** according to EN 61643-11
- Auxiliary switch ASAXSC-SPM for remote message transmission can be mounted onto the device

Technical Data

Inserts		SPCT2-075	SPCT2-135	SPCT2-175	SPCT2-280	SPCT2-335	SPCT2-385	SPCT2-460
Electrical								
Mechanical coding		x	x	x	x	x	x	x
Responding time (rate of voltage rise 5 kV/μs)		< 25 ns	< 25 ns	< 25 ns	< 25 ns	< 25 ns	< 25 ns	< 25 ns
Voltage protection level at nominal discharge current / U_{oc}	U_p	< 550 V	< 800 V	< 1.0 kV	< 1.4 kV	< 1.6 kV	< 1.8 kV	< 2.2 kV
Voltage protection level at 5 kA (8/20) μs	U_n	400 V	550 V	700 V	1000 V	1200 V	1350 V	1700 V
Max. continuous operating voltage	U_c	75 VAC	135 VAC	175 VAC	280 VAC	335 VAC	385 VAC	460 VAC
TOV test value (5 s)	U_T	= U_c	= U_c	= U_c	= U_c	= U_c	= U_c	= U_c
Rated frequency		50/60 Hz	50/60 Hz	50/60 Hz	50/60 Hz	50/60 Hz	50/60 Hz	50/60 Hz
Open circuit voltage	U_{oc}	—	—	—	10 kV	5 kV	—	—
Nominal discharge current (8/20) μs	I_n	15 kA	20 kA	20 kA	20 kA	20 kA	20 kA	20 kA
Charge Q at I_n		0.43 As	0.57 As	0.57 As	0.57 As	0.57 As	0.57 As	0.57 As
Specific energy at I_n		3.2 kJ/Ω	5.7 kJ/Ω	5.7 kJ/Ω	5.7 kJ/Ω	5.7 kJ/Ω	5.7 kJ/Ω	5.7 kJ/Ω
Max. discharge current	I_{max}	30 kA	40 kA	40 kA	40 kA	40 kA	40 kA	40 kA
Follow current interrupt rating	I_{fi}	—	—	—	—	—	—	—

Maximum back-up fuse
Maximum short-circuit current



Connection diagram

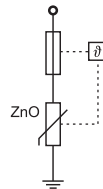

Mechanical

Frame size	45 mm
Device height	80 mm
Device width	
1pole	17.5 mm (1MU)
1+1pole, 2pole	35 mm (2MU)
3pole	52.5 mm (3TE)
3+1pole, 4pole	70 mm (4TE)
Mechanical coding	
1pole	x
1+1pole	yx
2pole	xx
3pole	xxx
3+1pole	yxxx
4pole	xxxx
Weight base 1P, 1+1P, 2P, 3P, 3+1P, 4P	53/120/120/180/240/240 g
Weight complete devices 1P, 1+1P, 2P, 3P, 3+1P, 4P	110/201/220/330/412/440 g
Permitted ambient temperature	-40°C to +70°C
Degree of protection (built-in)	IP40
Upper and lower lift terminal capacity	4 - 25 mm ²
Upper and lower open mouthed terminals for busbar thickness up to	1.5 mm
Tightening torque of terminal screws	2.4 - 3 Nm
Quick fastening on DIN rail according to	IEC/EN 60715
Accessories: busbars 16 mm ²	Type ZV-KSBI ...

Technical Data

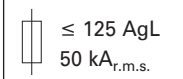
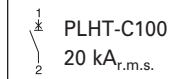
Inserts	SPCT2-580	SPCT2-NPE60
Electrical		
Mechanical coding	x	y
Responding time (rate of voltage rise 5 kV/ μ s)	< 25 ns	< 100 ns
Voltage protection level at nominal discharge current / U_{oc}	U_p < 2.6 kV	< 1.0 kV
Voltage protection level at 5 kA (8/20) μ s	U_p 2000 V	–
Max. continuous operating voltage	U_c 580 VAC	260 VAC
TOV test value	U_T = U_c (5 s)	1200 VAC (200 ms)
Rated frequency	50/60 Hz	50/60 Hz
Open circuit voltage	U_{oc} –	–
Nominal discharge current (8/20) μ s	I_n 20 kA	30 kA
Charge Q at I_n	0.57 As	0.57 As
Specific energy at I_n	5.7 kJ/ Ω	5.7 kJ/ Ω
Max. discharge current	I_{max} 40 kA	60 kA
Follow current interrupt rating	I_{fi} –	100 A _{r.m.s.}
Maximum back-up fuse		
Maximum short-circuit current		

Connection diagram

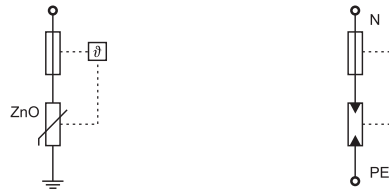



Mechanical

Frame size	45 mm
Device height	80 mm
Device width	
1pole	17.5 mm (1MU)
1+1pole, 2pole	35 mm (2MU)
3pole	52.5 mm (3TE)
3+1pole, 4pole	70 mm (4TE)
Mechanical coding	
1pole	x
1+1pole	yx
2pole	xx
3pole	xxx
3+1pole	yxxx
4pole	xxxx
Weight base 1P, 1+1P, 2P, 3P, 3+1P, 4P	53/120/120/180/240/240 g
Weight complete devices 1P, 1+1P, 2P, 3P, 3+1P, 4P	110/201/220/330/412/440 g
Permitted ambient temperature	-40°C to +70°C
Degree of protection (built-in)	IP40
Upper and lower lift terminal capacity	4 - 25 mm ²
Upper and lower open mouthed terminals for busbar thickness up to	1.5 mm
Tightening torque of terminal screws	2.4 - 3 Nm
Quick fastening on DIN rail according to	IEC/EN 60715
Accessories: busbars 16 mm ²	Type ZV-KSBI ...

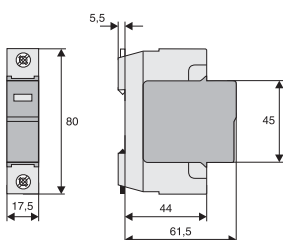
Dimensions (mm)



Technical Data

	SPCT2-1+NPE		SPCT2-3+NPE	
Electrical				
Mechanical coding			yx	yxxx
Responding time (rate of voltage rise 5 kV/ μ s)	L-N/N-PE/L-PE		< 25ns/< 100ns/< 100ns	< 25ns/< 100ns/< 100ns
Max. continuous operating voltage	L-N/N-PE	U_C	335VAC/260VAC	280VAC/260VAC
TOV test value		U_T		
5 s	L-N		415 VAC	350 VAC
200 ms	N-PE		1200 VAC	1200 VAC
Rated frequency			50/60 Hz	50/60 Hz
Nominal discharge current (8/20) μ s	L-N/N-PE/L-PE	I_n	20 kA	20 kA
Voltage protection level at I_n	L-N/N-PE/L-PE	U_p	$\leq 1600V/\leq 1000V/\leq 1650V$	$\leq 1000V/\leq 1000V/\leq 1300V$
Max. discharge current (8/20) μ s	L-N/N-PE/L-PE	I_{max}	40 kA	40 kA
Follow current interrupt rating	N-PE	I_{fi}	100 $A_{r.m.s.}$	100 $A_{r.m.s.}$
Maximum back-up fuse			 $\leq 125 AgL$	 PLHT-C100
Maximum short-circuit current			50 $kA_{r.m.s.}$	20 $kA_{r.m.s.}$

Connection diagram

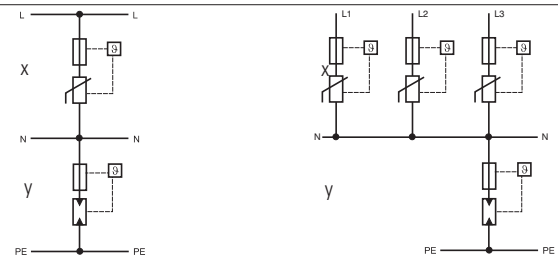

Mechanical

Mechanical coding of base	yx	yxxx
Frame size	45 mm	45 mm
Device height	80 mm	80 mm
Device width	35 mm	70 mm
Weight	201 g	412 g
Permitted ambient temperature	-40°C to +70°C	-40°C to +70°C
Degree of protection (built-in)	IP40	IP40
Upper and lower lift terminal capacity	1 - 25 mm ²	1 - 25 mm ²
Upper and lower open mouthed terminals for busbar thickness up to	1.5 mm	1.5 mm
Tightening torque of terminal screws	2.4 - 3 Nm	2.4 - 3 Nm
Quick fastening on DIN rail according to	IEC/EN 60715	IEC/EN 60715
Accessories: busbars 16 mm ²	Type ZV-KSBI ...	Type ZV-KSBI ...

Dimensions (mm)

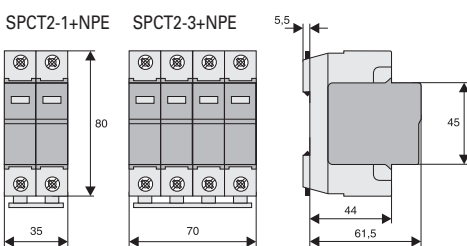

Application Examples

SPCT2-1+NPE

TN-, TT-System
3 x 230/400 VAC
3 x 240/415 VAC

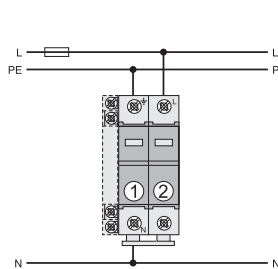

- ① ... SPCT2-NPE
- ② ... SPCT2-335

SPCT2-3+NPE

TN-S-, TT-System
3 x 230/400 VAC
3 x 240/415 VAC

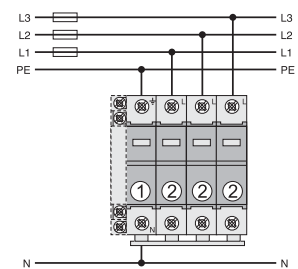

- ① ... SPCT2-NPE
- ② ... SPCT2-280

Surge arrester Sets

Surge Protective Class C, SPCT2

Surge Arrester Set SPCT2-335-3+NPE/BB

- The 3+1 circuit offers a universal solution for surge protection in low voltage distribution systems
- Suitable for TT- and TN-S-systems according to IEC 60364-5-53 Clause 534
- Remote message transmission is possibly by mounting auxiliary switch ASAXSC-SPM
- Busbar connected, minimum installation work required

Content

SPCT2-335-3+NPE/BB

- | | |
|--------------------------|-----------------------|
| - 1 unit SPCT2-335-3+NPE | Surge arrester |
| - 1 unit ASLTT-63 | Lead-through terminal |
| - busbar included | |

Poles	Max. Continuous Operating Voltage U_c	I_n (8/20) μ s	Type Designation	Article No.	Units per package
-------	---	----------------------	------------------	-------------	-------------------

Surge arrester SPET2, 1- to 4pole

Complete (2- and multi-pole surge arresters are supplied with busbar)

1pole	280 VAC	10 kA	SPET2-280/1	168741	2/120
2pole	280 VAC	2x10 kA	SPET2-280/2	168742	1/60
3pole	280 VAC	3x10 kA	SPET2-280/3	168692	1/40
4pole	280 VAC	4x10 kA	SPET2-280/4	168693	1/30
1pole+N	280 VAC	10 kA	SPET2-280/1+NPE	168699	1/60
3pole+N	280 VAC	10 kA	SPET2-280/3+NPE	168700	1/30
1pole	335 VAC	10 kA	SPET2-335/1	168695	2/120
2pole	335 VAC	2x10 kA	SPET2-335/2	168696	1/60
3pole	335 VAC	3x10 kA	SPET2-335/3	168697	1/40
4pole	335 VAC	4x10 kA	SPET2-335/4	168698	1/30
1pole+N	335 VAC	10 kA	SPET2-335/1+NPE	168701	1/60
3pole+N	335 VAC	10 kA	SPET2-335/3+NPE	168702	1/30

SG64212



SPET2-280/2

Surge arrester SPET2, Insert

Insert 1pole

Insert	280 VAC	10 kA	SPET2-280	168740	2/120
Insert	335 VAC	10 kA	SPET2-335	168694	2/120

sg63412



Accessories

Auxiliary switch for SPBT12, SPCT2, SPET2, SPDT3	ASAUWSC-SPM	131785	8/80
--	-------------	--------	------

SG83311



Description	Type Designation	Article No.	Units per package
-------------	------------------	-------------	-------------------

Lead-through terminal for SPB, ASLTT-63

Lead-through terminal	ASLTT-63	131784	12/120
-----------------------	----------	--------	--------



SG59511



Description Surge arrester SPET2

- Field of application:
For the protection of low voltage distribution systems against transient overvoltage caused by direct and indirect lightning stroke and switching operations
- Test class **[II]** according to IEC 61643-1+A1
- SPD-type **[T2]** according to EN 61643-11
- Busbars ZV-KSBI are available for all customary applications
- Suitable for busbar connection to all Xtra Combinations switchgear

Technical Data

		SPET2-280	SPET2-335	SPET2-NPE60
Electrical				
Responding time (rate of voltage rise 5 kV/μs)		< 25 ns	< 25 ns	< 100 ns
Voltage protection level at nominal discharge current	U_p	< 1.2kV	< 1.3kV	< 1.0 kV
Voltage protection level at 5 kA (8/20) μs	U_p	1000 V	1200 V	-
Max. continuous operating voltage	U_c	280 VAC	335 VAC	260 VAC
TOV test value (5 s)	U_T	335 VAC	400 VAC	1200 VAC
Rated frequency		50/60 Hz	50/60 Hz	50/60 Hz
Nominal discharge current (8/20) μs	I_n	10 kA	10 kA	20 kA
Charge Q at I_n		0.57 As	0.57 As	0.57 As
Specific energy at I_n		5.7 kJ/Ω	5.7 kJ/Ω	5.7 kJ/Ω
Max. discharge current	I_{max}	20 kA	20 kA	60 kA
Follow current interrupt rating	I_{fi}	-	-	100 A _{r.m.s.}
Maximum back-up fuse		 ≤ 100 AgL	 ≤ C63	
Maximum short-circuit current		50 kA _{r.m.s.}	10 kA _{r.m.s.}	

Connection diagram



Mechanical

Frame size	45 mm
Device height	80 mm
Device width	17.5 mm
Weight	87 g
Permitted ambient temperature	-40°C to +70°C
Degree of protection (built-in)	IP40
Upper and lower lift terminal capacity	4 - 25 mm ²
Upper and lower open mouthed terminals for busbar thickness up to	1.5 mm
Tightening torque of terminal screws	2 - 2.5 Nm
Quick fastening on DIN rail according to	IEC/EN 60715
Accessories: busbars 16 mm ²	Type ZV-KSBI ...

Dimensions (mm)

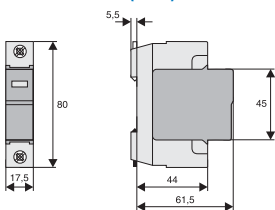

Application Examples SPET2 according to IEC 60364-5-53 Clause 534

TN-C-System
3 x 230/400 VAC
(3 x 220/380 VAC)
(3 x 240/415 VAC)

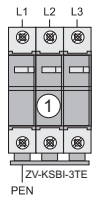

TN-S-System
3 x 230/400 VAC
(3 x 220/380 VAC)
(3 x 240/415 VAC)

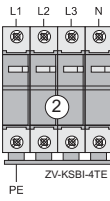

TT-System
3 x 230 VAC
(3 x 220 VAC)



TN-S-/TT-System
3 x 230/400 VAC
(3 x 220/380 VAC)
(3 x 240/415 VAC)



TN-S-System
1 x 230 VAC
(1 x 220 VAC)
(1 x 240 VAC)

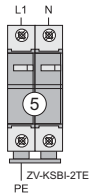

TN-S-/TT-System
1 x 230 VAC
(1 x 220 VAC)
(1 x 240 VAC)

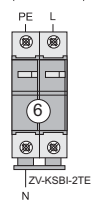

TN-S-/TT-System
1 x 230 VAC
(1 x 220 VAC) (1 x 240 VAC)

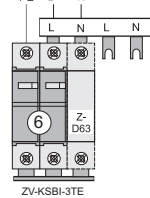

TN-S-/TT-System
230 VAC

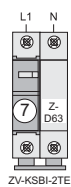

TN-S-/TT-System
3 x 230/400 VAC

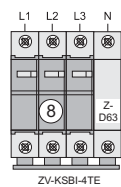

		①	②	③	④
	IEC 60364-5-534 IEC 60364-5-53 Clause 534	SPET2-280/3	SPET2-280/4	---	SPET2-335/3+NPE
	ÖVE ÖNORM E8001-1	SPET2-335/3	SPET2-335/4	---	SPET2-335/3+NPE
	VDE V 0100-534	SPET2-280/3	SPET2-280/4	---	SPET2-335/3+NPE
		SPET2-280/3	SPET2-280/4	SPET2-280/3	---

		⑤	⑥	⑦	⑧
	IEC 60364-5-534 IEC 60364-5-53 Clause 534	SPET2-280/2	SPET2-335/1+NPE	---	---
	ÖVE ÖNORM E8001-1	SPET2-335/2	SPET2-335/1+NPE	---	---
	VDE V 0100-534	SPET2-280/2	SPET2-335/1+NPE	---	---
	UTE C 20-443	---	---	SPET2-280/1	SPET2-280/3

Description Auxiliary switch for Surge arrester ASAUXSC-SPM

- Field of application:
For mounting onto surge protective devices for external defect message transmission
- Design basically in accordance with IEC 60947-5-1
- Can be mounted subsequently
- Suitable with SPBT12, SPCT2, SPET2, SPDT3, SP-B+C

Technical Data

	ASAUXSC-SPM
Electrical	
Rated insulation voltage	250 V
Rated frequency	50/60 Hz
Switching contact	1 CO
Minimum voltage per contact	24 VAC
Rated operational current AC12	2 A / 250 VAC
Maximum back-up fuse	2 A gL
Overvoltage category	IV
Pollution degree	2
Mechanical	
Frame size	45 mm
Device height	80 mm
Device width	8.8 mm
Mounting	Screw-mounting
Degree of protection, built-in	IP40
Terminal protection	finger and hand touch safe according to DGUV VS3, EN 50274
Upper and lower terminals	lift terminals
Terminal capacity	2 x 2.5 mm ²
Tightening torque of terminal screws	0.8 - 1 Nm

Connection diagram

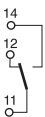

Dimensions (mm)

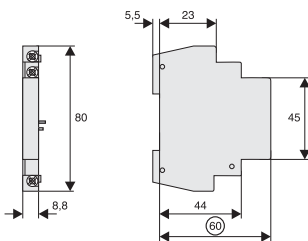

Application Examples

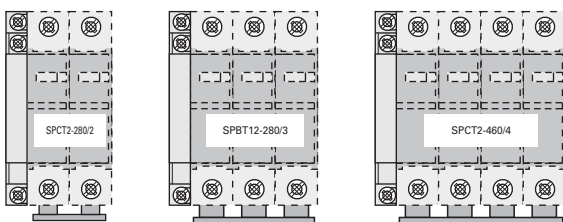

Description Lead-Through Terminal for Surge Protective Devices, SPD-type 2 (Surge Protective Class C), ASLTT-63

- The lead-through terminal permits orderly wiring of SPDs types 2 (Surge Protective Class C).
It serves as lead-through terminal in circuits requiring vertical connections from the upper to the lower SPD connection level.
- 1pole
- Suitable for standard busbar connection to EATON switchgear

Technical Data

	ASLTT-63
Electrical	
Rated voltage	690 V AC/DC
Rated current	63 A
Rated frequency	50/60 Hz
Mechanical	
Frame size	45 mm
Device height	80 mm
Device width	17.5 mm
Mounting	quick fastening on DIN rail IEC/EN 60715
Degree of protection, built-in	IP40
Terminal protection	finger and hand touch safe according to DGUV VS3, EN 50274
Upper and lower terminals	Lift- and Maulklemme
Terminal capacity	1 - 25 mm ²
Busbar thickness	0.8 - 2 mm
Tightening torque of terminal screws	2.4 - 3 Nm

Connection diagram



Dimensions (mm)

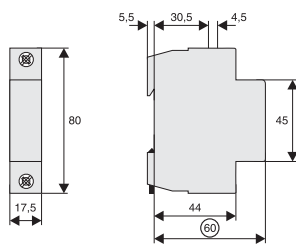

Application Example / Connection type 2 according to IEC 60364-5-53 Clause 534

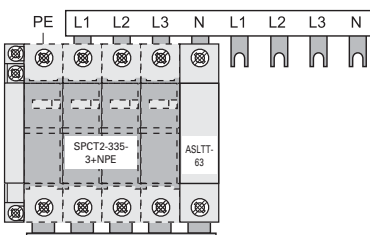

Poles	Max. Continuous Operating Voltage U_c	Type Designation	Article No.	Units per package
-------	--	---------------------	-------------	----------------------

Surge arrester SPDT3

Complete (2-pole surge arresters are supplied with busbar)

1pole+N	335 VAC	SPDT3-335-1+NPE	170487	1/60
2pole	280 VAC	SPDT3-280/2	170485	1/60

SG03213



SPDT3-335-1+NPE

Max. Continuous Operating Voltage U_c	Type Designation	Article No.	Units per package
--	---------------------	-------------	----------------------

Surge arrester SPDT3, Insert

Insert 1pole

280 VAC	SPDT3-280	170484	2/120
335 VAC	SPDT3-335	170486	2/120



sg03413



Description Surge Protective Class T3

- Field of application:
For fine protection of user equipment against transient overvoltage
- For mounting on DIN rails in distribution boxes for electrical installation
- No decoupling from upstream surge protection in the low voltage distribution system required
- Test class III according to IEC 61643-1+A1
- SPD-type T3 according to EN 61643-11
- Suitable for high back-up fuse 63 A gL / C 63
- Auxiliary switch ASAXSC-SPM for remote message transmission can be mounted onto the device

Technical Data

		SPDT3-335-1+NPE		SPDT3-280/2	
Electrical					
Mechanical coding			yx		xx
Responding time (rate of voltage rise 5 kV/μs)		L-N/N-PE/L-PE	< 25ns/< 100ns/< 100ns	L1-L2(N)/L2(N)-PE/L1-PE	< 25ns
Max. continuous operating voltage	U_C	L-N/N-PE	335VAC/260VAC	L1-L2(N)/L2(N)-PE	280VAC
TOV test value	U_T				
5 s		L-N/L-PE	350VAC/416VAC	L-N/L-PE	350VAC/416VAC
200 ms		N-PE	1200VAC	N-PE	1200VAC
Rated frequency			50/60 Hz		50/60 Hz
Open circuit voltage	U_{OC}	L-N/N-PE/L-PE	6kV	L1-L2(N)/L2(N)-PE/L1-PE	6kV
Voltage protection level at UOC	U_p	L-N/N-PE/L-PE	≤ 900V/≤ 1500V/≤ 900V	L1-L2(N)/L2(N)-PE	≤ 900V
Nominal discharge current (8/20) μs	I_n	L-N/N-PE/L-PE	2.5kA	L1-L2(N)/L2(N)-PE	5kA
Voltage protection level at I_n	U_p	L-N/N-PE/L-PE	≤ 1000V/≤ 1500V/≤ 1000V	L1-L2(N)/L2(N)-PE	≤ 950V
Max. discharge current (8/20) μs	I_{max}	L-N/N-PE/L-PE	10kA	L1-L2(N)/L2(N)-PE/L1-PE	10kA
Follow current interrupt rating	I_{fi}	N-PE	100 A _{r.m.s.}		–
Maximum back-up fuse			 ≤ 125 AgL 50 kA _{r.m.s.}		
Maximum short-circuit current				 ≤ C63 10 kA _{r.m.s.}	

Connection diagram



Mechanical

Mechanical coding of base	yx	xx
Frame size	45 mm	45 mm
Device height	80 mm	80 mm
Device width	35 mm	35 mm
Weight	220 g	220 g
Permitted ambient temperature	-40°C to +70°C	-40°C to +70°C
Degree of protection (built-in)	IP40	IP40
Upper and lower lift terminal capacity	1 - 25 mm ²	1 - 25 mm ²
Upper and lower open mouthed terminals for busbar thickness up to	1.5 mm	1.5 mm
Tightening torque of terminal screws	2.4 - 3 Nm	2.4 - 3 Nm
Quick fastening on DIN rail according to	IEC/EN 60715	IEC/EN 60715

Dimensions (mm)

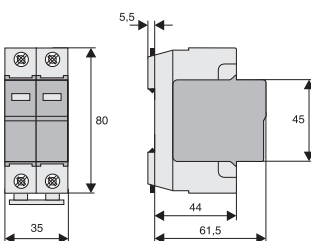

Application Examples

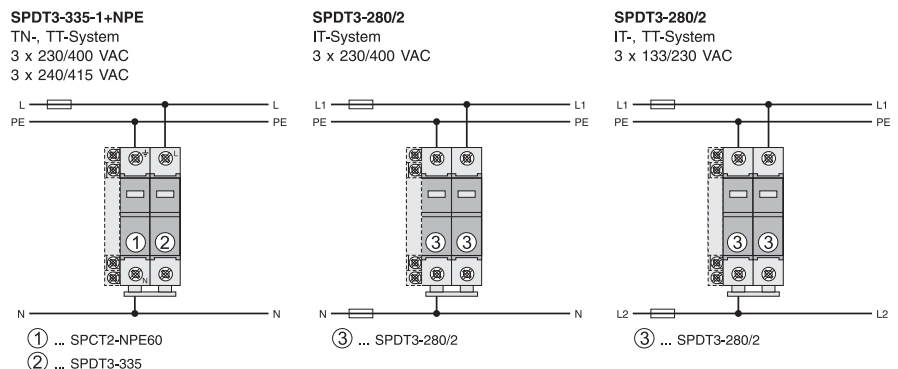

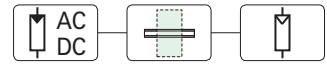

Max. continuous operating voltage
U_C

Type
Designation

Article No.

Units per
package

Plug-in Surge Arrester SPPVT2 for Photovoltaic application

- For insulated and earthed systems

sg04914



600 V DC	SPPVT2-06-2+PE	176088	1 / 40
1000 V DC	SPPVT2-10-2+PE	176090	1 / 40

With auxiliary switch

600 V DC	SPPVT2-06-2+PE-AX	176087	1 / 40
1000 V DC	SPPVT2-10-2+PE-AX	176089	1 / 40

sg04714



Inserts for replacement

600 V DC	SPPVT2-06	176091	1 / 50
1000 V DC	SPPVT2-10	176092	1 / 50

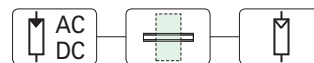

Description Plug-in Surge Arrester SPPVT2-...-2+PE(-AX)

- Increased safety through compliance with the EN 50539-11 standard
- Safe contacting thanks to integrated redary bolts
- Easy to replace thanks to a plug-type arrester
- Optimal protection of the inverter thanks to a low protection level
- Selective replacement of defective connectors thanks to a visual status indicator
- Optimized planning of maintenance interventions thanks to remote signalling (Type -AX)
- No wrong connecting possible thanks to coded connectors and base elements

Connection diagram

SPPVT2(H)-...-2+PE(-AX)

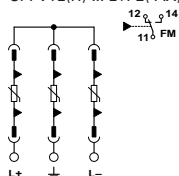

Dimensions (mm)

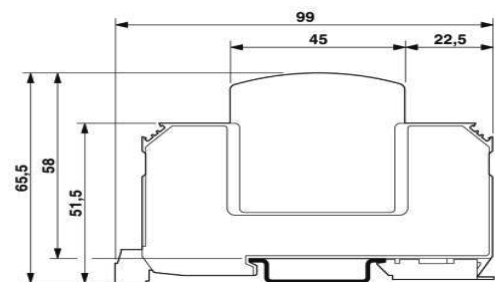

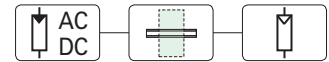

Technical Data

	SPPVT2-06-2+PE(-AX)	SPPVT2-10-2+PE(-AX)
Environmental condition		
Degree of protection	IP20	IP20
Ambient temperature of operation	-40 ... +80°C	-40 ... +80°C
Altitude	≤ 2000 m	≤ 2000 m
Allowed range of air humidity of operation	5 ... 95 %	5 ... 95 %
General		
Standards/regulations	EN 50539-11	EN 50539-11
EN Test class	PV T2	PV T2
SPD failure performance	OCM	OCM
Mounting	DIN rail 35 mm	DIN rail 35 mm
Material of the enclosure	PBT/PA	PBT/PA
Pollution degree	II	II
Flammability class according to UL 94	V0	V0
Signal for surge protection defective	visual, with remote signalling contact	visual, with remote signalling contact
Predictive circuit on the direct current side (DC)		
Max. continuous operating voltage	U_{CPV} 800 V DC	1170 V DC
No-load output voltage	U_{OCSTC} ≤ 670 V DC	≤ 970 V DC
Short-circuit current strength	I_{SCPV} 2000 A	2000 A
Nominal load current	I_L 80 A DC	80 A DC
Predictive conductor current	I_{PE}	
DC	≤ 20 µA	≤ 20 µA
AC	≤ 300 µA	≤ 250 µA
Standby power consumption	P_c ≤ 20 mVA	≤ 25 mVA
Nominal discharge current (8/20) µs	15 kA	15 kA
Maximum discharge current (8/20) µs	I_{max} 40 kA	40 kA
Total lightning discharge current (8/20) µs	I_{Total} 40 kA	40 kA
Voltage protection level (L+) - (L-)	U_p ≤ 2.7 kV	≤ 3.7 kV
Voltage protection level (L+/L-) - PE	U_p ≤ 2.7 kV	≤ 3.7 kV
Responding time	t_A ≤ 25 ns	≤ 25 ns
Size		
Hight	99 mm	99 mm
Width	53.4 mm	53.4 mm
Depth	65.5 mm	65.5 mm
Module units (MU)	3 MU	3 MU
Weight		
...+PE	gross 313 g / net 288 g	gross 337 g / net 311 g
...+PE-AX	gross 320 g / net 294 g	gross 343 g / net 317 g
Connection data		
Type of connection	Screw connection	Screw connection
Lift terminal capacity		
flexible	1.5-25 mm ²	1.5-25 mm ²
solid	1.5-35 mm ²	1.5-35 mm ²
Bolt thread	M5	M5
Tightening torque	4.5 Nm	4.5 Nm
Stripping length	16 mm	16 mm
Type of connection	Biconnect-terminals	Biconnect-terminals
Lift terminal capacity		
solid	1.5-16 mm ²	1.5-16 mm ²
Bolt thread	M6	M6
Tightening torque	30 lb in	30 lb in
Auxiliary Switch		
Switching function	CO, 1-pole	CO, 1-pole
Rated operational voltage	5 ... 250 V AC, 30 V DC	5 ... 250 V AC, 30 V DC
Rated operational current	5 mA ... 1.5 A AC, 1.5 A DC	5 mA ... 1.5 A AC, 1.5 A DC
Type of connection	MC 1.5/3	MC 1.5/3
Lift terminal capacity		
flexible	0.14-1.5 mm ²	0.14-1.5 mm ²
solid	0.14-1.5 mm ²	0.14-1.5 mm ²
Lift terminal capacity AWG/kcmil	30 ... 14	30 ... 14
Bolt thread	M2	M2
Tightening torque	0.25 Nm, 2 ... 4 lb in	0.25 Nm, 2 ... 4 lb in
Stripping length	7 mm	7 mm

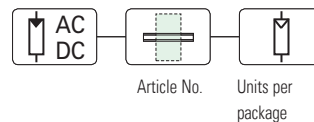

Max. continuous operating voltage
 U_c

Type
 Designation

Article No.

Units per
 package

Plug-in Surge Arrester SPPVT12 for Photovoltaic application

- For insulated and earthed systems

sg04914



600 V DC	SPPVT12-06-2+PE	177258	1 / 40
1000 V DC	SPPVT12-10-2+PE	177256	1 / 40

With auxiliary switch

600 V DC	SPPVT12-06-2+PE-AX	177257	1 / 40
1000 V DC	SPPVT12-10-2+PE-AX	177255	1 / 40

sg04714



Inserts for replacement

600 V DC	SPPVT12-06	177259	1 / 50
1000 V DC	SPPVT12-10	177260	1 / 50

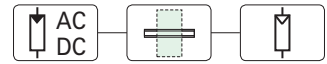

Description Plug-in Surge Arrester SPPVT12-...-2+PE(-AX)

- Increased safety through compliance with the EN 50539-11 standard
- Safe contacting thanks to integrated redary bolts
- Easy to replace thanks to a plug-type arrester
- Optimal protection of the inverter thanks to a low protection level
- Selective replacement of defective connectors thanks to a visual status indicator
- Optimized planning of maintenance interventions thanks to remote signalling (Type -AX)
- No wrong connecting possible thanks to coded connectors and base elements
- Always the right arrester thanks to universal Type1/Type2 preductive components

Connection diagram

SPPVT12-...-2+PE(-AX)

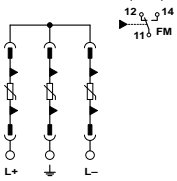



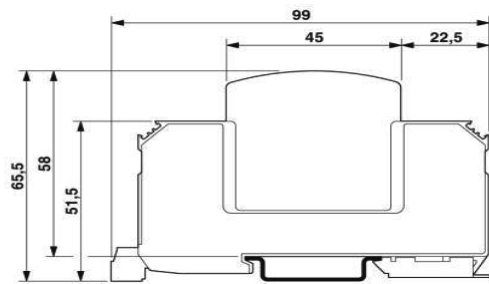

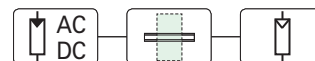

Dimensions (mm)





Technical Data

		SPPVT12-06-2+PE(-AX)	SPPVT12-10-2+PE(-AX)
Environmental condition			
Degree of protection		IP20	IP20
Ambient temperature of operation		-40 ... +80°C	-40 ... +80°C
Altitude		≤ 2000 m	≤ 2000 m
Allowed range of air humidity of operation		5 ... 95 %	5 ... 95 %
General			
Standards/regulations		EN 50539-11	EN 50539-11
EN Test class		PV T1/PV T2	PV T1/PV T2
SPD failure performance		OCM	OCM
Mounting		DIN rail 35 mm	DIN rail 35 mm
Material of the enclosure		PBT/PA	PBT/PA
Pollution degree		II	II
Flammability class according to UL 94		V0	V0
Signal for surge protection defective		visual, with remote signalling contact	visual, with remote signalling contact
Predictive circuit on the direct current side (DC)			
Max. continuous operating voltage	U_{CPV}	720 V DC	1050 V DC
No-load output voltage	U_{OCSTC}	≤ 600 V DC	≤ 875 V DC
Short-circuit current strength	I_{SCPV}	2000 A	2000 A
Nominal load current	I_L	80 A DC	80 A DC
Predictive conductor current	I_{PE}		
DC		≤ 20 μA	≤ 20 μA
AC		≤ 350 μA	≤ 350 μA
Standby power consumption	P_C	≤ 20 mVA	≤ 25 mVA
Nominal discharge current (8/20) μs		15 kA	15 kA
Maximum discharge current (8/20) μs	I_{max}	40 kA	40 kA
Lightning test current (10/350) μs, Peak current	I_{imp}	5 kA	5 kA
Total lightning discharge current (8/20) μs	I_{Total}	7 kA	5 kA
Voltage protection level (L+) - (L-)	U_p	≤ 2.6 kV	≤ 357 kV
Voltage protection level (L+/L-) - PE	U_p	≤ 2.6 kV	≤ 3.5 kV
Responding time	t_A	≤ 25 ns	≤ 25 ns
Required max. back-up fuse with stub-line wiring		not necessary	not necessary
Size			
Height		99 mm	99 mm
Width		53.4 mm	53.4 mm
Depth		65.5 mm	65.5 mm
Module units (MU)		3 MU	3 MU
Weight			
...+PE		gross 407 g / net 379 g	gross 407 g / net 379 g
...+PE-AX		gross 414 g / net 386 g	gross 414 g / net 386 g
Connection data			
Type of connection		Screw connection	Screw connection
Lift terminal capacity			
flexible		1.5-25 mm ²	1.5-25 mm ²
solid		1.5-35 mm ²	1.5-35 mm ²
Bolt thread		M5	M5
Tightening torque		4.5 Nm	4.5 Nm
Stripping length		16 mm	16 mm
Type of connection		Biconnect-terminals	Biconnect-terminals
Lift terminal capacity			
solid		1.5-16 mm ²	1.5-16 mm ²
Bolt thread		M6	M6
Tightening torque		30 lb in	30 lb in
Auxiliary Switch			
Switching function		CO, 1-pole	CO, 1-pole
Rated operational voltage		5 ... 250 V AC, 30 V DC	5 ... 250 V AC, 30 V DC
Rated operational current		5 mA ... 1.5 A AC, 1.5 A DC	5 mA ... 1.5 A AC, 1.5 A DC
Type of connection		MC 1.5/3	MC 1.5/3
Lift terminal capacity			
flexible		0.14-1.5 mm ²	0.14-1.5 mm ²
solid		0.14-1.5 mm ²	0.14-1.5 mm ²
Lift terminal capacity AWG/kcmil		30 ... 14	30 ... 14
Bolt thread		M2	M2
Tightening torque		0.25 Nm, 2 ... 4 lb in	0.25 Nm, 2 ... 4 lb in
Stripping length		7 mm	7 mm

Poles	Type Designation	Article No.	Units per package
Busbar Z-GV-U/ for SPI, SP-B+C			
	Z-GV-U/2	272588	20 / 1200
	Z-GV-U/3	272589	20 / 1200
	Z-GV-U/4	274080	20 / 1200
	Z-GV-U/5	274081	20 / 1200
	Z-GV-U/6	274082	20 / 400
	Z-GV-U/8	274083	20 / 200
	Z-GV-U/9	274084	20 / 200

Description busbar Z-GV-U/

- Busbars Z-GV-U/ permit to implement customary SPD combinations
- Suitable for SPI-..., SPB-D-125
- The rated cross-section of Z-GV-U/ is 16 mm²
- The busbars must be cut to length in some cases

Technical Data

	Z-GV-U/
Electrical	
Rated voltage	230/400 V, 50/60 Hz
Rated current	63 A
Mechanical	
Busbar cross section	16 mm ² Cu

Design

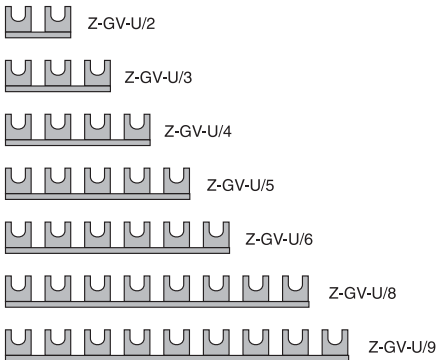

1.34

Photovoltaic - Surge Protection









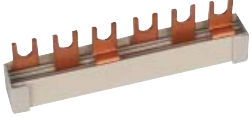





xPole

Busbar

Used for	Type Designation	Article No.	Units per package
Busbar Z-GV-16/3P-3TE/6			
for SPI and SPC	Z-GV-16/3P-3TE/6	267511	12 / 240

WA_SG11202



Poles	Type Designation	Article No.	Units per package
Busbar ZV-KSBI for SPC			
	2MU	ZV-KSBI-2MU	263961 10 / 600
	3MU	ZV-KSBI-3TE	263962 10 / 600
	3MU	ZV-KSBI-3TE/S	263963 10 / 600
	2MU+1.5MU	ZV-KSBI-3TE+HI	112370 50 / 150
	4MU	ZV-KSBI-4TE	263964 10 / 600
	5MU	ZV-KSBI-5TE	263965 10 / 200
	5MU	ZV-KSBI-5TE/N	263966 10 / 200
	2MU+3x1.5MU	ZV-KSBI-5TE+HI	112371 50 / 150
	6MU	ZV-KSBI-6TE	113118 50 / 500
	7MU	ZV-KSBI-7TE	263967 50 / 500
	7MU	ZV-KSBI-7TE/S	263968 10 / 100
	7MU	ZV-KSBI-7TE/N	263969 10 / 100
	9MU	ZV-KSBI-9TE/N	266874 50 / 500
	11MU	ZV-KSBI-11MU	263970 50 / 500

Description busbar ZV-KSBI

- With the ZV KSBI busbar bracket you can realize the common combinations of arrestors.
- Used for SPB-..., SPC-..., Z-D63
- The rated cross-section of the ZV-KSBI bridge metals is 16 mm²
- The busbar mounting bracket can be shortened

Technical Data

	Z-GV-U/
Electrical	
Rated voltage	230/400 V, 50/60 Hz
Rated current	63 A
Mechanical	
Busbar cross section	16 mm ² Cu

Design

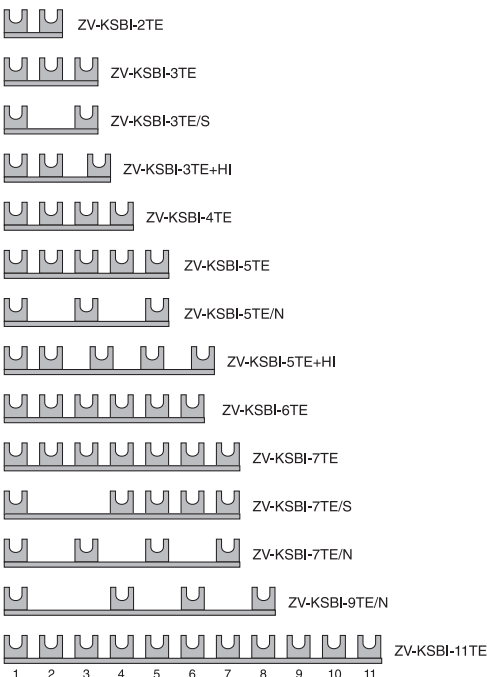



Description	Type Designation	Article No.	Units per package
19" Multiple Outlet Strips NWS-STL/19/7F			
7outlets, DIN	NWS-STL/19/7F	255398	1
7outlets plus switch, DIN	NWS-STL/19/7F/S/BL	255399	1
7outlets, UTE	NWS-STL/19/7F/UTE	290031	1



Description 19" Multiple Outlet Strips NWS-STL/19/7F

- Installation onto 19" rails
- Installation height: 1U
- Diagonally arranged socket outlets with earthing contact according to DIN 49440 or NF-C61314 (UTE), 16 A / 250 V AC
- Connection cable of 2.5 m H05VV-F 3G 1.5 mm² with an angled connector
- Max. power consumption: 3680 W
- Degree of protection: IP20
- Temperature range: -5 to +40 °C
- Dimensions: 482.6x44x44.45 mm (WxDxH)
- Material: Enclosure made of aluminium, front cover made of plastic similar to RAL 7035
- Weight: approx. 0.9 kg
- Scope of delivery: 1 Outlet strip incl. 19" fixing bracket, different fixing material

19" Multiple Outlet Strips with Surge Protection SPD-STL/19/7F-S/BL			
7outlets plus switch, DIN	SPD-STL/19/7F-S/BL	283449	1
7outlets, UTE	SPD-STL/19/7F-S/BL/UTE	290032	1



Description 19" Multiple Outlet Strips with Surge Protection SPD-STL/19/7F-S/BL

- Can be mounted on 19" rails
- Installation height: 1U
- Diagonally arranged socket outlets with earthing contact according to DIN 49440 or NF-C61314 (UTE), 16 A / 250 V AC
- Connection cable of 2.5 m H05VV-F 3G 1.5 mm² with an angled connector
- On/Off switch, 2-pole, lit
- Max. power consumption: 3680 W
- Degree of protection: IP20
- Temperature range: -5 up to +40 °C
- Surge protection tested according to IEC 61643-1 (Class: SPD Type 3)
- Response time: < 25 ns
- Dimensions: 482.6x44x44.45 mm (WxDxH)
- Material: Enclosure made of aluminium, front cover made of plastic similar to RAL 7035
- Weight: approx. 0.9 kg
- Scope of delivery: 1 Outlet strip incl. 19" fixing bracket, different fixing material



Description	Type Designation	Article No.	Units per package
Surge Protection Multiple Outlet Strips with High-Range Filter and Energy Absorption for full Equipment Protection SPD-STL/6F-S			
6outlets plus switch, DIN	SPD-STL/6F-S (68583)	130000	1
6outlets plus switch, DIN+ISDN	SPD-STL/6F-S/ISDN (68585)	147795	1
19" fixing bracket for SPD-STL/6F-S (1U)	NWS-HW/19/SPD-STL/6F-S	166364	1

N04011



Description Surge Protection Multiple Outlet Strips with High-Range Filter and Energy Absorption for full Equipment Protection SPD-STL/6F-S

- Suitable for wall-mounting in indoor areas
- A 19" fixing bracket is available as an option for mounting the strip in a cabinet
- Diagonally arranged socket outlets with earthing contact according to DIN 49440, 10 A / 250 V AC
- Connection cable of 1.0 m H05VV-F 3G 1.0 mm² with an angled connector
- On/Off switch with MCB that can be reset
- Max. power consumption: 2500 W
- Degree of protection: IP20
- Temperature range: -15 to +70 °C
- Surge protection tested according to IEC 61643-1 (Class: SPD Type 3)
- Response time: < 1 ns
- Dimensions: 390x42x52 mm (WxDxH)
- Material: Enclosure made of plastic similar to RAL 7021
- Weight: approx. 0.4 kg
- Scope of delivery: 1 Multiple outlet strip

Eaton is a power management company with 2017 sales of \$20.4 billion. We provide energy-efficient solutions that help our customers effectively manage electrical, hydraulic and mechanical power more efficiently, safely and sustainably. Eaton is dedicated to improving the quality of life and the environment through the use of power management technologies and services. Eaton has approximately 96,000 employees and sells products to customers in more than 175 countries.

For more information, visit Eaton.com.



Eaton Industries (Austria) GmbH
Scheydgasse 42
1210 Vienna
Austria

Eaton
EMEA Headquarters
Route de la Longeraie 7
1110 Morges, Switzerland
Eaton.eu

© 2019 Eaton
All Rights Reserved
Printed in Austria
Publication No.
Article number-MK
January 2019
Graphics: SRA, Schrems

Changes to the products, to the information contained in this document, and to prices are reserved; so are errors and omissions. Only order confirmations and technical documentation by Eaton is binding. Photos and pictures also do not warrant a specific layout or functionality. Their use in whatever form is subject to prior approval by Eaton. The same applies to Trademarks (especially Eaton, Moeller, and Cutler-Hammer). The Terms and Conditions of Eaton apply, as referenced on Eaton Internet pages and Eaton order confirmations.

Eaton is a registered trademark.

All other trademarks are property of their respective owners.

Follow us on social media to get the latest product and support information.

